

## Differential pressure transmitter CP 114 – CP 115

### KEY POINTS

- Ranges from -500/+500 mbar to -2000/+2000 mbar (according to models)
- Configurable intermediary ranges
- 0-10 V or 4-20 mA output, active, power supply 24 Vac/Vdc (3-4 wires) or 4-20 mA output, passive loop, power supply from 16 to 30 Vdc (2 wires)
- ABS V0 housing, IP65, with or without display
- "¼ turn" system mounting with wall-mount plate
- Housing with simplified mounting system



### FEATURES OF THE HOUSING

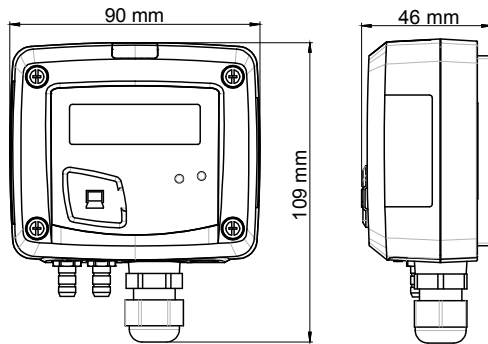

**Material:** ABS V0 as per UL94

**Protection:** IP65

**Display:** LCD 10 digits. Size: 50 x 17 mm

**Height of digits:** Value: 10 mm; Unit: 5 mm

**Connections:** safety Ø6.2 mm

**Cable gland:** for cables Ø8 mm maximum

**Weight:** 143 g

### TECHNICAL FEATURES

<b>Measurement units</b>	mbar, inWG, mmHG, PSI, mmH <sub>2</sub> O, daPa, hPa, kPa
<b>Accuracy*</b>	±1.5% of reading ±3 mbar
<b>Response time</b>	1/e (63%) 0.3 s
<b>Resolution</b>	1 mbar; 0.1 inWG; 1 mmHG; 1 mmH <sub>2</sub> O; 1 hPa; 10 daPa; 0.1 kPa; 0.1 PSI
<b>Autozero</b>	Manual with push-button
<b>Type of fluid</b>	Air and neutral gases
<b>Overpressure tolerated</b>	<b>CP114:</b> 1400 mbar; <b>CP115:</b> 4100 mbar
<b>Conditions of use (°C/%RH/m)</b>	From 0 to +50°C. In non-condensing condition. From 0 to 2000 m.
<b>Storage temperature</b>	From -10 to +70°C

\*All the accuracies indicated in this technical datasheet were stated in laboratory conditions, and can be guaranteed for measurements carried out in the same conditions, or carried out with calibration compensation.

### PART NUMBER

To order, just add the codes to complete the part number:

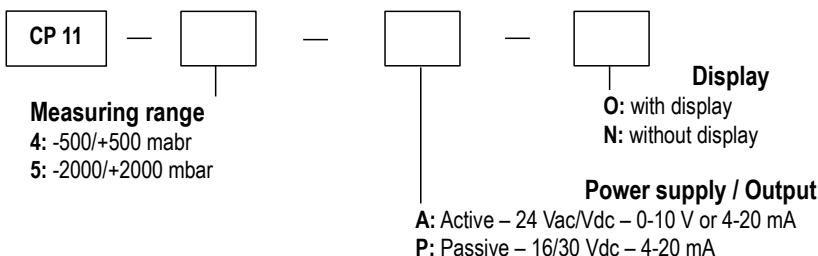

**Example: CP 114 – AO**

Pressure transmitter measuring range -500/+500 mbar, 0-10 V or 4-20 mA active, with display

## TECHNICAL SPECIFICATIONS

<b>Output / Supply</b>	<ul style="list-style-type: none"> <li>- active sensor 0-10 V or 4-20 mA (alim. 24 Vac/Vdc <math>\pm 10\%</math>), 3-4 wires</li> <li>- passive loop 4-20 mA (power supply 16/30 Vdc), 2 wires</li> <li>- common mode voltage &lt;30 VAC</li> <li>- maximum load: 500 Ohms (4-20 mA) / minimum load: 1 K Ohms (0-10 V)</li> </ul>
<b>Consumption</b>	2 VA (0-10 V) or 0.6 VA (4-20 mA)
<b>European directives</b>	2014/30/EU EMC; 2014/35/EU Low Voltage; 2011/65/EU RoHS II; 2012/19/EU WEEE
<b>Electrical connection</b>	Screw terminal block for cables from 0.05 to 2.5 mm <sup>2</sup> or from 30 to 14 AWG Carried out according to the code of good practice
<b>Communication to PC</b>	USB-mini DIN cable
<b>Environment</b>	Air and neutral gases

## CONNECTIONS

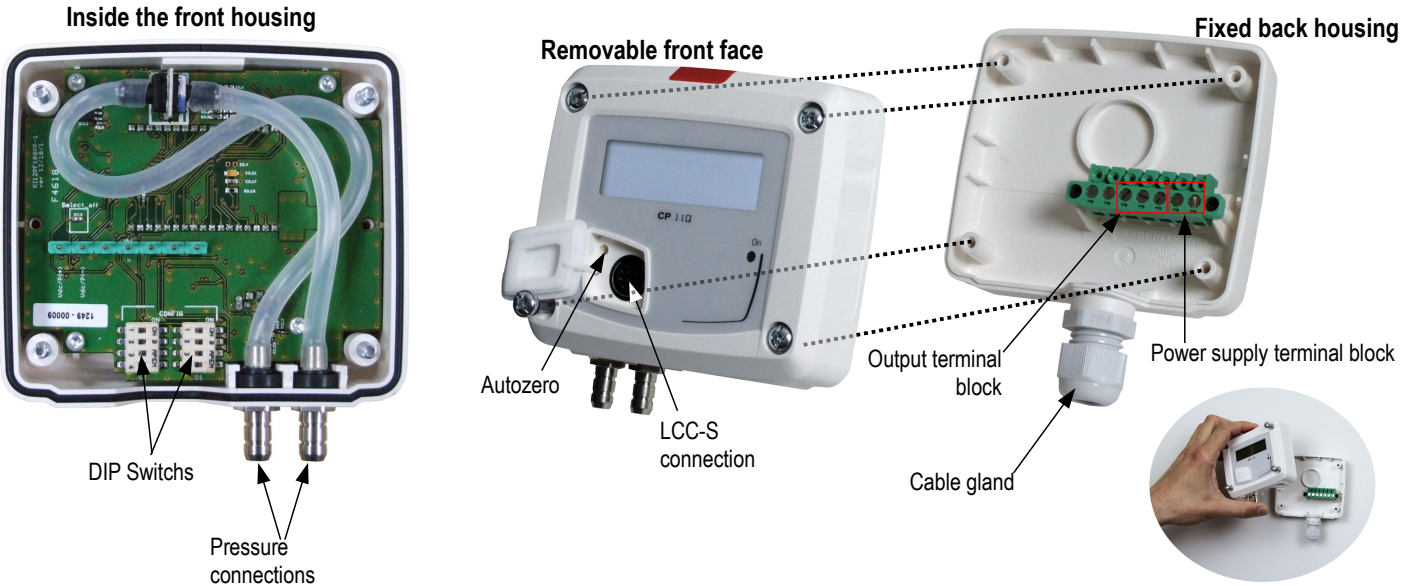

## ELECTRICAL CONNECTIONS – as per *NFC15-100 standard*



This connection must be made by a qualified and trained technician. To make the connection, the transmitter must not be energized.

For CP114/115 – AO models and CP114/115 – AN models with 0-10 V or 4-20 mA output – active, 4 wires :

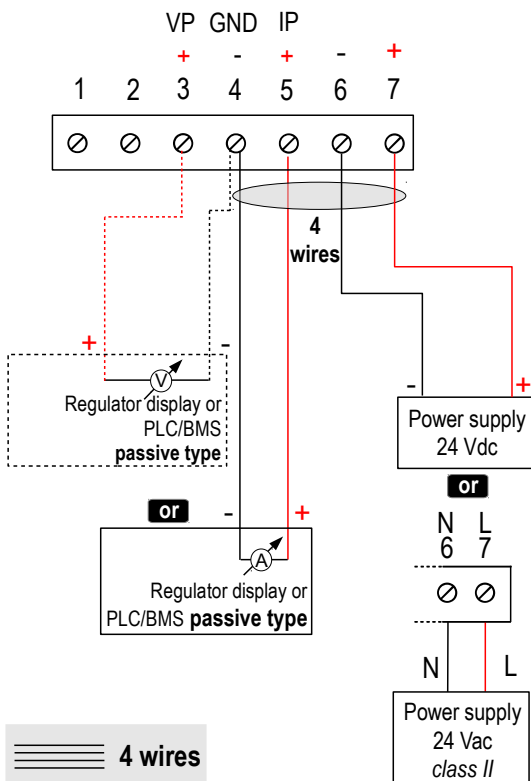

To make a 3-wire connection, before powering up the transmitter, please connect the output ground to the input ground. See drawing below.

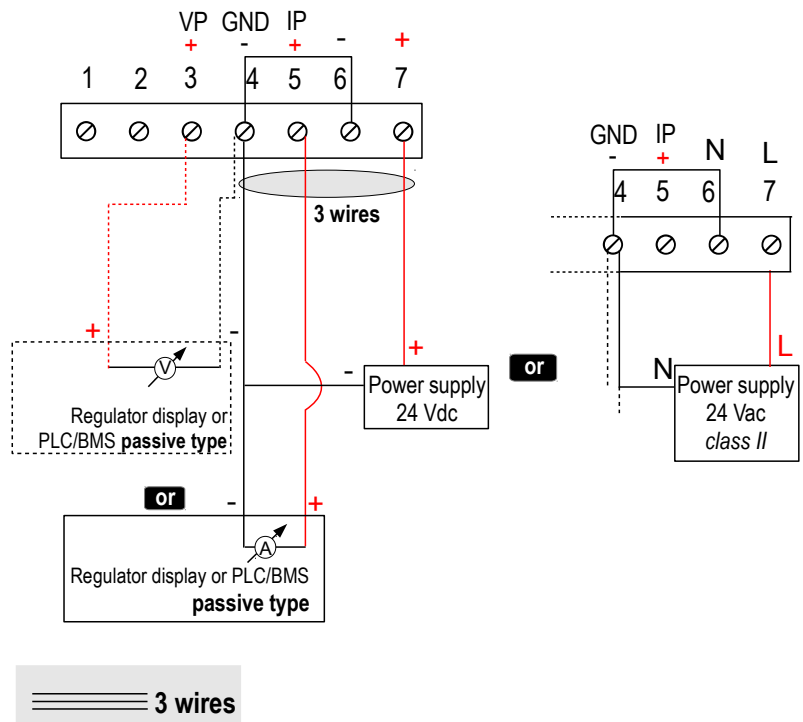

For CP114/115 – PO models and CP114/115 – PN models with 4-20 mA output – **passive**:

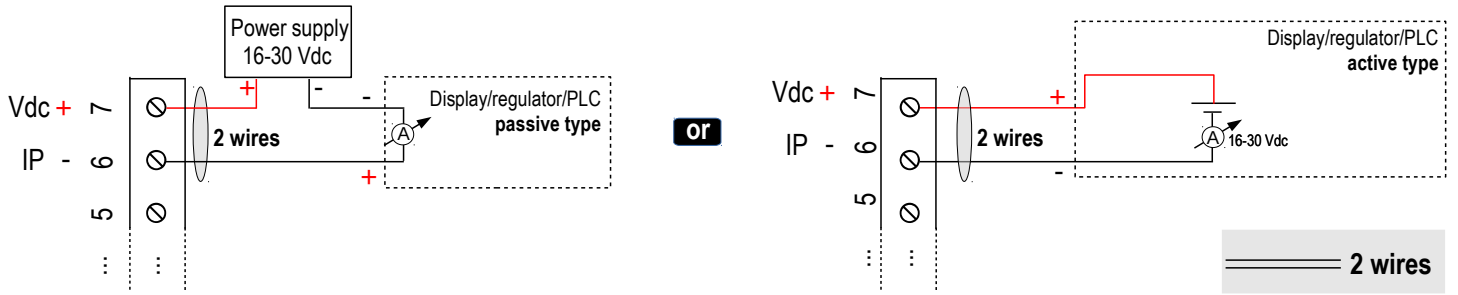

## SETTINGS AND USE OF THE TRANSMITTER

### > Autozero

To perform an autozero, unplug the 2 pressure connections tubes and press the “**Autozero**” key.

When an autozero has been performed, “**On**” green light turns off then turns on, and on transmitters equipped with a display, “**autoZ**” is displayed.

### > Configuration



To configure the transmitter, it must not be energized. Then, you can make the settings required, with the DIP switches (as shown on the drawing below). When the transmitter is configured, you can power it up.

To configure the transmitter, unscrew the 4 screws from the housing then open it. DIP switches allowing the different settings are then accessible.

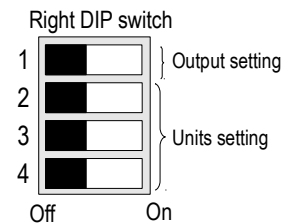
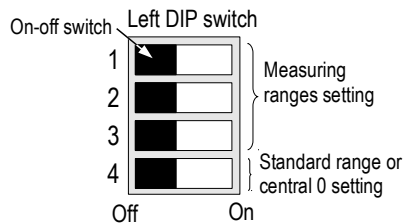

### > Measuring range settings – left DIP switch

To set a measuring range, put the 1, 2 and 3 on-off switches as indicated in the table below.

Type of transmitter	Combination 1		Combination 2		Combination 3		Combination 4		Combination 5	
	CP114	CP115	CP114	CP115	CP114	CP115	CP114	CP115	CP114	CP115
mbar	100	500	200	750	300	1000	400	1500	500	2000
inWG	40.0	200.0	80.0	300.0	120.0	400.0	160.0	600.0	200.00	800.0
kPa	10.0	50.0	20.0	75.0	30.0	100.0	40.0	150.0	50.0	200.0
PSI	2.0	10.0	4.0	15.0	6.0	20.0	8.0	30.0	10.0	40.0
mmHg	80	400	160	600	240	800	320	1200	400	1600
mmH <sub>2</sub> O	1000	5000	2000	7500	3000	10 000	4000	15 000	5000	20000
daPa	1.0	5.0	2.0	7.5	3.0	10.0	4.0	15.0	5.0	20.0
hPa	100	500	200	750	300	1000	400	1500	500	2000

- Measuring ranges of the CP114 transmitter on the **±500 mbar range** according to the measurement unit.
- Measuring ranges of the CP115 transmitter on the **±2000 mbar range** according to the measurement unit.

Example:

- From 0 to 750 mmH<sub>2</sub>O, measuring range is 750 mmH<sub>2</sub>O.
- From -500 mbar to +500 mbar, measuring range is 1000 mbar.

### > Standard range / central zero setting – left DIP switch

To set the type of measuring range, put the on-off switch 4 as indicated beside:









Example 0-100 mbar: Full scale / 0 (0 / 100 mbar)  
 Central zero (-50 mbar / 0 / +50 mbar)

Configurations	Full scale	Central zero
Combinations		

 Please follow carefully the combinations beside with the DIP switch. If the combination is wrongly done, the following message will appear on the display of the transmitter "CONF ERROR". In that case, you will have to unplug the transmitter, place the DIP switches correctly, and then power the transmitter up.

































> **Output setting – right DIP switch (CP114/115 – AO and CP114/115 – AN models)**

To set the type of analogue output, please put the on-off switch of the output as shown beside.

Configurations	4-20 mA	0-10 V
Combinations	1 	1 
	2 	2 
	3 	3 
	4 	4 

> **Units setting – right DIP switch**

To set a measurement unit, put the on-off switches 2, 3 and 4 of the units as shown in the table below.

Configurations	mbar	inWG	kPa	PSI	mmHG	mmH <sub>2</sub> O	daPa	hPa
Combinations	1 	1 	1 	1 	1 	1 	1 	1 
	2 	2 	2 	2 	2 	2 	2 	2 
	3 	3 	3 	3 	3 	3 	3 	3 
	4 	4 	4 	4 	4 	4 	4 	4 

**CONFIGURATION VIA LCC-S SOFTWARE (option)**

**An easy and friendly configuration with the software!**

You can configure your own intermediary ranges.

**Caution : the minimum difference between the high range and the low range is 20.**

For example, it is possible to set the instrument from -20 to 0 mbar, from 0 to +20 mbar, or from -10 to +10 mbar...

• To access the configuration via software:

- Set the DIP switches as shown beside. *Nota : the on-off switch 1 of the right DIP switch can be in any position (selection of the analogue output 0-10 V or 4-20 mA)*

- Connect the cable of the LCC-S to the connection of the transmitter.

• Please refer to the user manual of the LCC 100 to make the configuration.

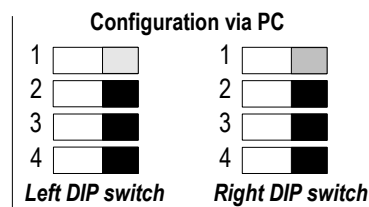

**The configuration of the parameters can be done either with the DIP switch or via software (you can not combine both solutions).**

**MOUNTING**

To mount the transmitter, mount the ABS plate on the wall (drilling: Ø6 mm, screws and pins are supplied).

Insert the transmitter on the fixing plate (see A on the drawing beside). Rotate the housing in clockwise direction until you hear a "click" which confirms that the transmitter is correctly installed.

 **Once the transmitter is installed and powered up, please make an autozero to guarantee the correct working of the transmitter in any position.**

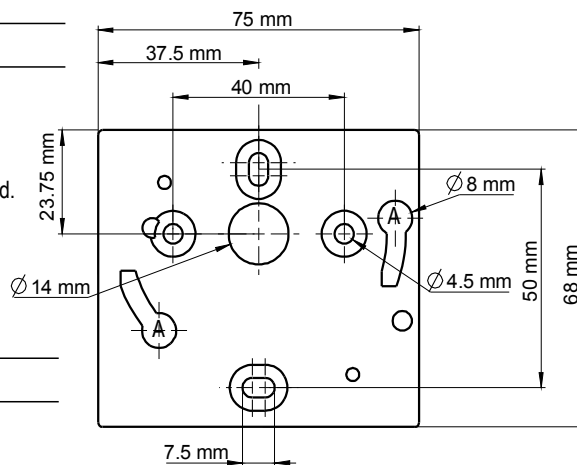

**MAINTENANCE**

Please avoid any aggressive solvent. Please protect the transmitter and its probes from any cleaning product containing formalin, that may be used for cleaning rooms or ducts.

**OPTIONS AND ACCESSORIES**

- **KIAL-100A:** Power supply class 2, 230 Vac input, 24 Vac output
- **KIAL-100C:** Power supply class 2, 230 Vac input, 24 Vdc output
- **LCC-S:** configuration software with USB cable
- Connection tube
- Connection fittings
- Through-connections
- Straight connections
- Spherical coupling nut

 **Only the accessories supplied with the device must be used.**

**PRECAUTIONS FOR USE**

Please always use the device in accordance with its intended use and within parameters described in the technical features in order not to compromise the protection ensured by the device.

 Once returned to KIMO, required waste collection will be assured in the respect of the environment in accordance with European guidelines relating to WEEE.

[www.kimo.fr](http://www.kimo.fr)

Distributed by :



**EXPORT DEPARTMENT**  
Tel : + 33. 1. 60. 06. 69. 25 - Fax : + 33. 1. 60. 06. 69. 29  
e-mail : [export@kimo.fr](mailto:export@kimo.fr)